

• General Description

It combines advanced trench MOSFET technology with a low resistance package to provide extremely low $R_{DS(ON)}$. It combines one N Channel MOSFET and one P channel MOSFET.

• Features

- Advance high cell density Trench technology
- Low $R_{DS(ON)}$ to minimize conductive loss
- Low Gate Charge for fast switching
- Dual DIE in one package

• Application

- Power Management in Notebook Computer
- BLDC Motor driver

• Ordering Information:

Part NO.	ZMC88212L
Marking	88212
Packing Information	REEL TAPE
Basic ordering unit (pcs)	4000

• N Channel Absolute Maximum Ratings ($T_C = 25^\circ\text{C}$)

Parameter	Symbol	Rating	Unit
Drain-Source Voltage	V_{DS}	20	V
Gate-Source Voltage	V_{GS}	± 12	V
Continuous Drain Current	$I_{D@T_C=25^\circ\text{C}}$	4	A
	$I_{D@T_C=75^\circ\text{C}}$	3	A
	$I_{D@T_C=100^\circ\text{C}}$	2.5	A
Pulsed Drain Current ^①	I_{DM}	12	A
Total Power Dissipation	$P_D@T_C=25^\circ\text{C}$	9	W
Total Power Dissipation	$P_D@T_A=25^\circ\text{C}$	0.45	W
Operating Junction Temperature	T_J	-55 to 150	$^\circ\text{C}$
Storage Temperature	T_{STG}	-55 to 150	$^\circ\text{C}$
Single Pulse Avalanche Energy	E_{AS}	5	mJ

• Product Summary

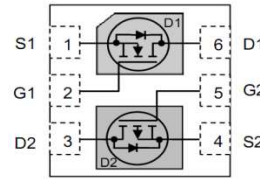

$V_{DS1} = 20\text{V}$
 $V_{DS2} = -20\text{V}$
 $R_{DS(ON)1} = 33\text{m}\Omega$
 $R_{DS(ON)2} = 75\text{m}\Omega$
 $I_{D1} = 4\text{A}$
 $I_{D2} = -3\text{A}$

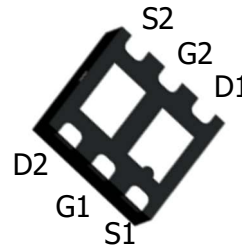

DFN2*2

**•P Channel Absolute Maximum Ratings (T_C =25°C)**

Parameter	Symbol	Rating	Unit
Drain-Source Voltage	V _{DS}	-20	V
Gate-Source Voltage	V _{GS}	±12	V
Continuous Drain Current	I _{D@T_C=25°C}	-3	A
	I _{D@T_C=75°C}	-2.3	A
	I _{D@T_C=100°C}	-1.9	A
Pulsed Drain Current ^①	I _{DM}	-9	A
Total Power Dissipation	P _{D@T_C=25°C}	9	W
Total Power Dissipation	P _{D@T_A=25°C}	0.45	W
Operating Junction Temperature	T _J	-55 to 150	°C
Storage Temperature	T _{STG}	-55 to 150	°C
Single Pulse Avalanche Energy	E _{AS}	5	mJ

•Thermal resistance

Parameter	Symbol	Min.	Typ.	Max.	Unit
Thermal resistance, junction - case	R _{thJC}	-	-	6.9	° C/W
Thermal resistance, junction - ambient	R _{thJA}	-	-	180	° C/W
Soldering temperature, wavesoldering for 10s	T _{sold}	-	-	265	° C

•N Channel Electronic Characteristics

Parameter	Symbol	Condition	Min.	Typ	Max.	Unit
Drain-Source Breakdown Voltage	BV _{DSS}	V _{GS} =0V, I _D =250uA	20			V
Gate Threshold Voltage	V _{GS(TH)}	V _{GS} =V _{DS} , I _D =250uA	0.5	0.8	1.2	V
Drain-Source Leakage Current	I _{DSS}	V _{DS} =20V, V _{GS} =0V			1.0	uA
Gate- Source Leakage Current	I _{GSS}	V _{GS} =±12V, V _{DS} =0V			±100	nA
Static Drain-source On Resistance	R _{DS(ON)}	V _{GS} =4.5V, I _D =4A		33	45	mΩ
		V _{GS} =2.5V, I _D =3A		40	60	mΩ
Forward Transconductance	g _{FS}	V _{DS} =10V, I _D =1A		2		s

**•Electronic Characteristics**

Parameter	Symbol	Condition	Min.	Typ	Max.	Unit
Input capacitance	Ciss	V _{DS} =15V f = 1MHz	-	293	-	pF
Output capacitance	Coss		-	28	-	
Reverse transfer capacitance	Crss		-	25	-	

•Gate Charge characteristics(T_a = 25°C)

Parameter	Symbol	Condition	Min.	Typ	Max.	Unit
Total gate charge	Qg	V _{DD} =15V	-	8	-	nC
Gate - Source charge	Qgs	I _D = 4A	-	0.4	-	
Gate - Drain charge	Qgd	V _{GS} = 10V	-	1.5	-	

•P Channel Electronic Characteristics

Parameter	Symbol	Condition	Min.	Typ	Max.	Unit
Drain-Source Breakdown Voltage	BV _{DSS}	V _{GS} =0V, I _D =-250uA	-20			V
Gate Threshold Voltage	V _{GS(TH)}	V _{GS} =V _{DS} , I _D =-250uA	-0.5	-0.8	-1.2	V
Drain-Source Leakage Current	I _{DSS}	V _{DS} =-20V, V _{GS} =0V			-1.0	uA
Gate- Source Leakage Current	I _{GSS}	V _{GS} =±12V, V _{DS} =0V			±100	nA
Static Drain-source On Resistance	R _{DS(ON)}	V _{GS} =-4.5V, I _D =-3A		70	85	mΩ
		V _{GS} =-2.5V, I _D =-2.5A		80	110	mΩ
Forward Transconductance	g _{FS}	V _{DS} =-10V, I _D =-1A		1.5		s

•Electronic Characteristics

Parameter	Symbol	Condition	Min.	Typ	Max.	Unit
Input capacitance	Ciss	V _{DS} =-15V f = 1MHz	-	430	-	pF
Output capacitance	Coss		-	74	-	
Reverse transfer capacitance	Crss		-	68	-	

•Gate Charge characteristics(T_a = 25°C)

Parameter	Symbol	Condition	Min.	Typ	Max.	Unit
Total gate charge	Qg	V _{DD} = -15V	-	10.7	-	nC
Gate - Source charge	Qgs	I _D = -3A	-	0.6	-	
Gate - Drain charge	Qgd	V _{GS} = -10V	-	2.2	-	

•N Channel characteristics curve

Fig.1 Power Dissipation

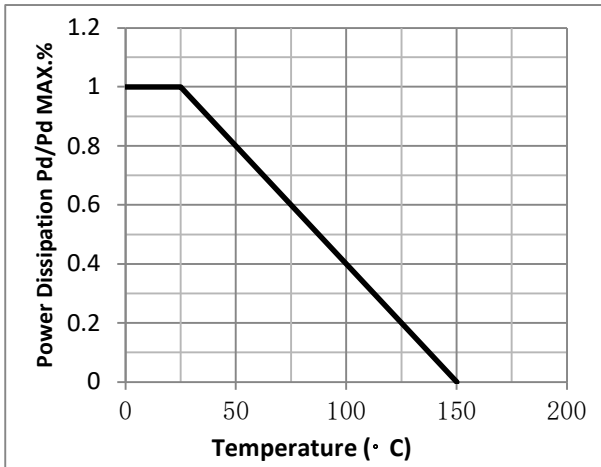

Fig.2 Typical output Characteristics

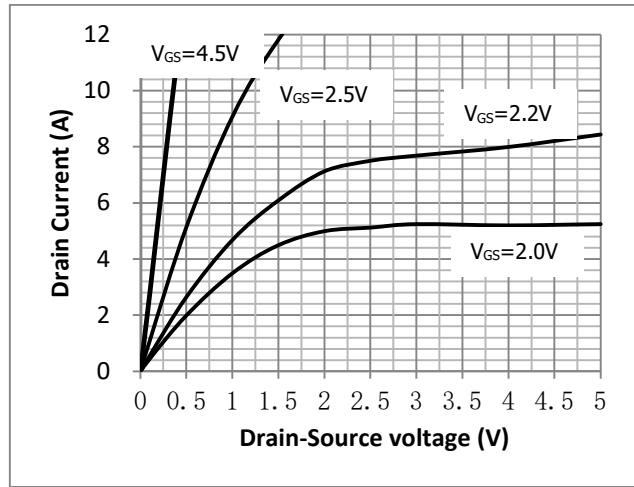

Fig.3 Threshold Voltage V_{gs(th)} V.S Junction Temperature

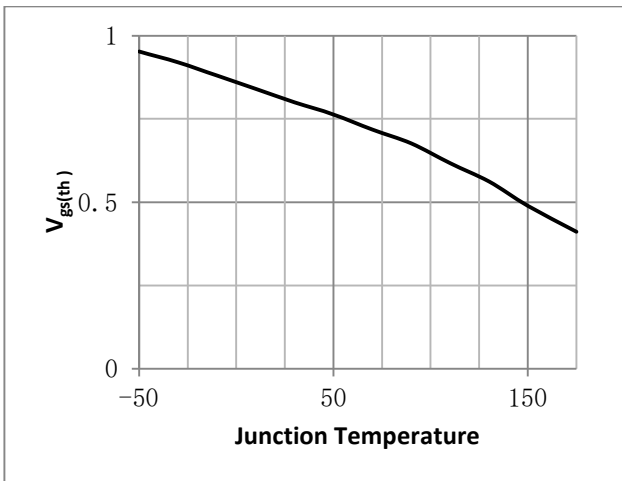

Fig.4 Resistance V.S Drain Current

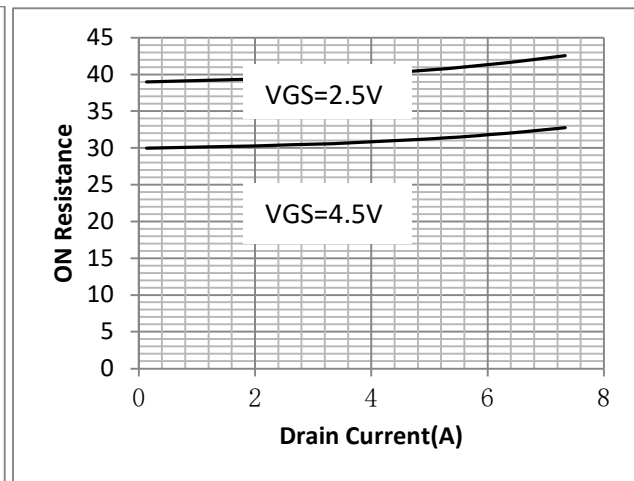

Fig.5 On-Resistance VS Gate Source Voltage

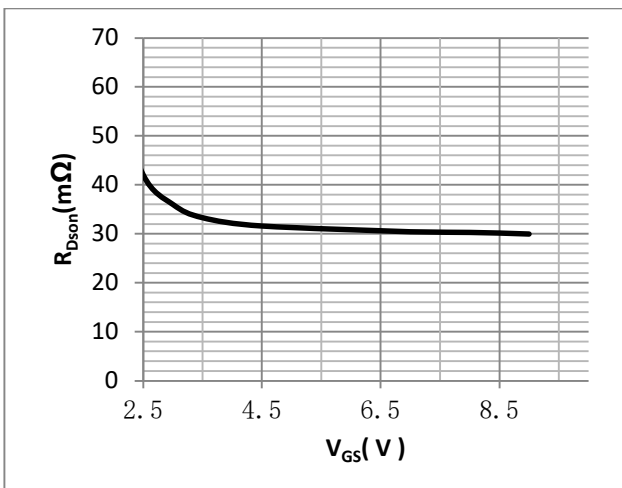

Fig.6 On-Resistance V.S Junction Temperature

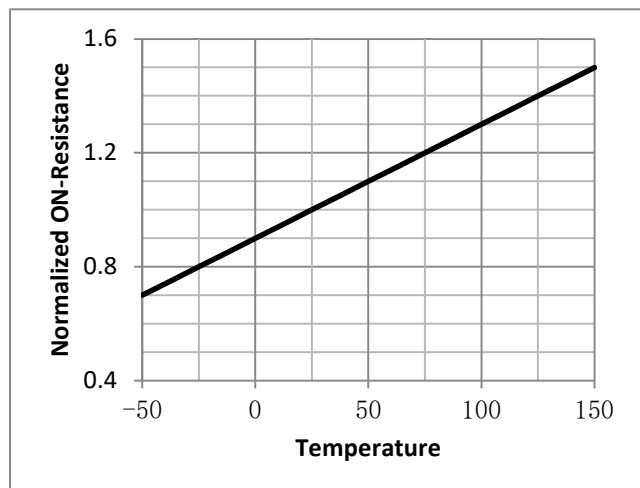

Fig.7 Gate-Charge Characteristics

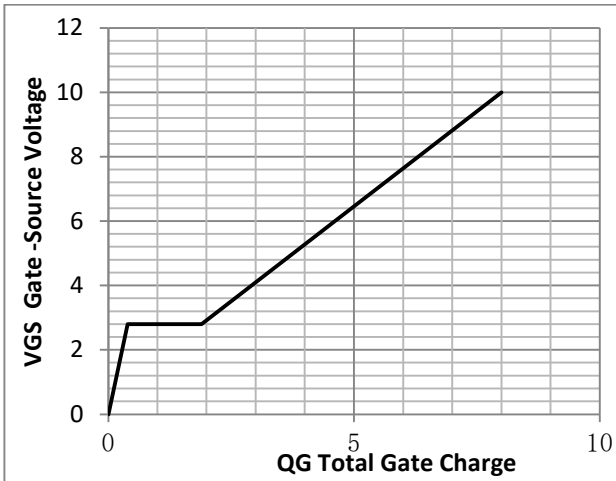

Fig.8 Capacitance Characteristics

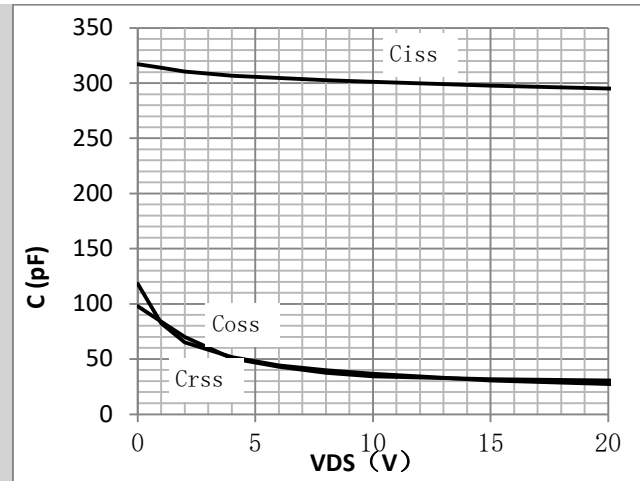

Fig.9 SOA Maximum Safe Operating Area

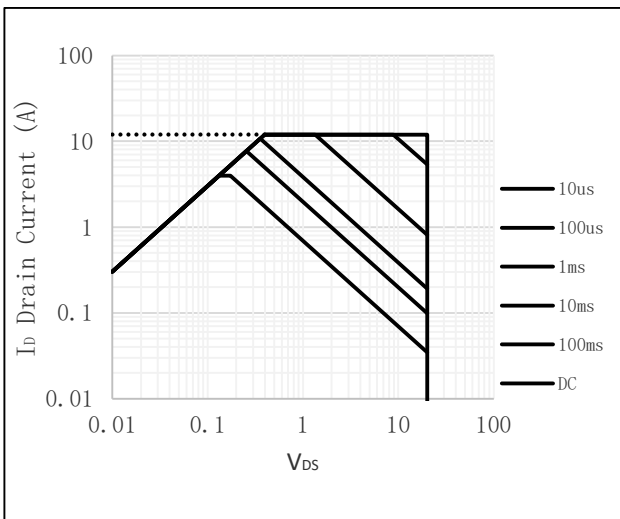
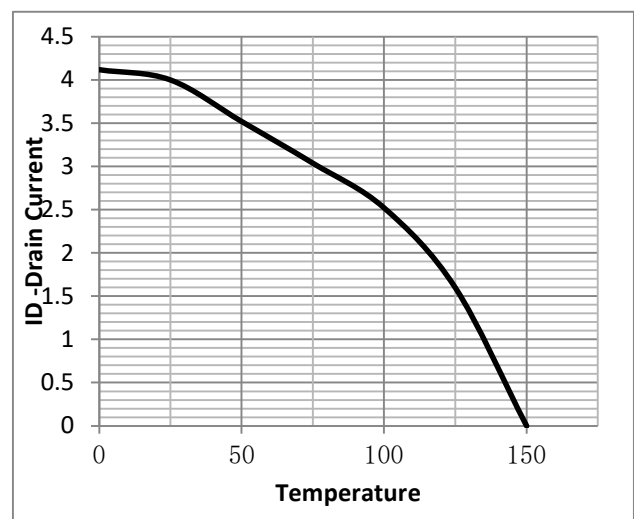

Fig.10 ID-Junction Temperature



•P Channel characteristics curve

Fig.1 Power Dissipation Derating Curve

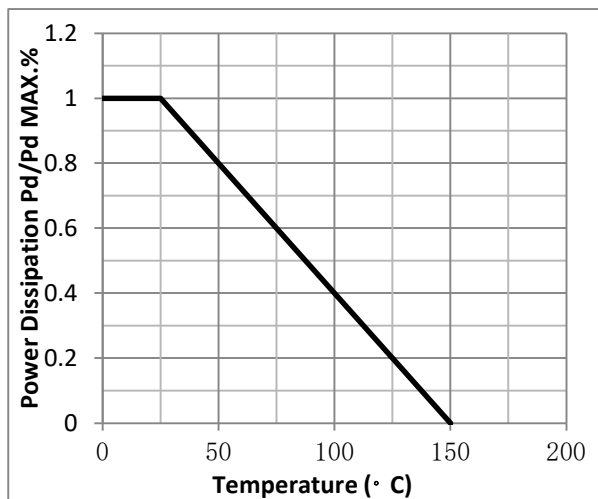

Fig.2 Typical output Characteristics

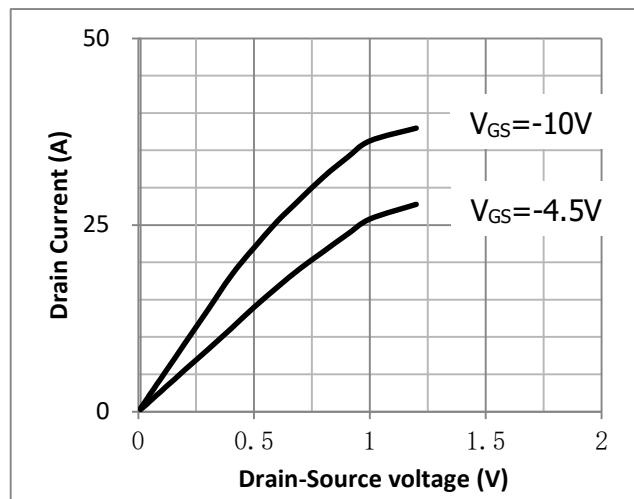

Fig.3 Threshold Voltage V.S Junction Temperature

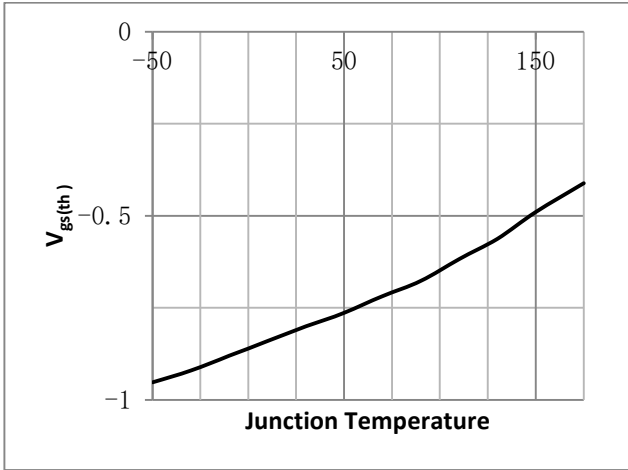

Fig.4 Resistance V.S Drain Current

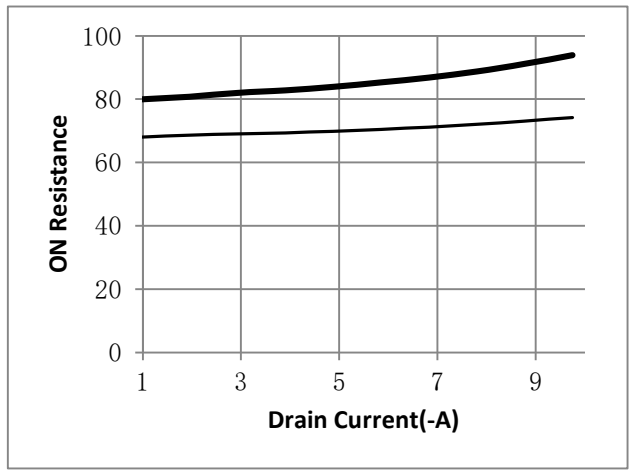

Fig.5 On-Resistance VS Gate Source Voltage

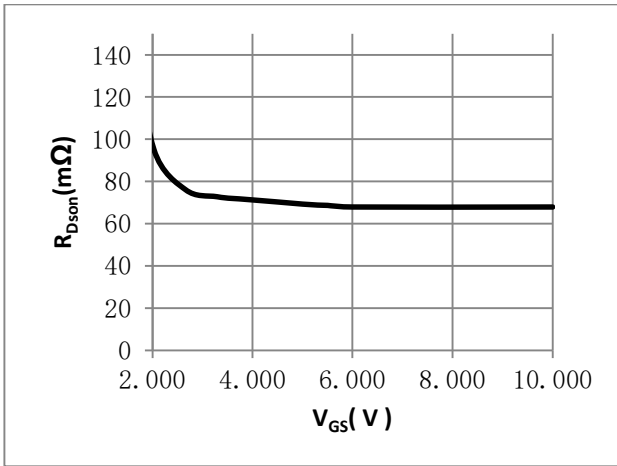

Fig.6 On-Resistance V.S Junction Temperature

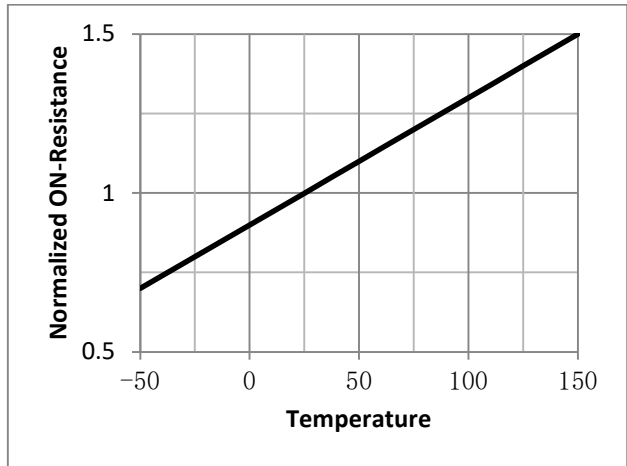

Fig.7 Capacitance Characteristics

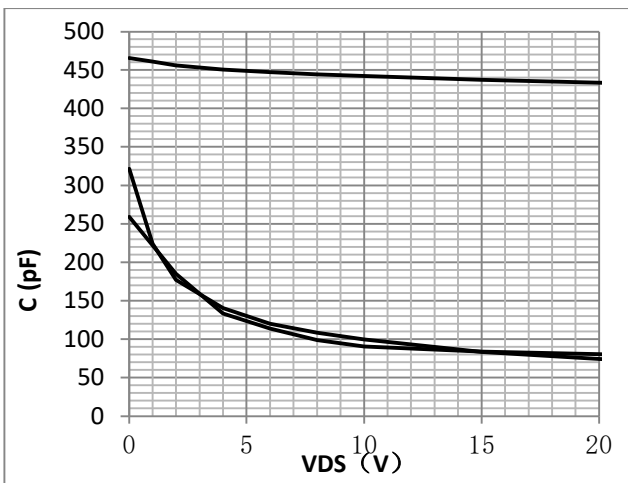

Fig.8 Gate-Charge Characteristics

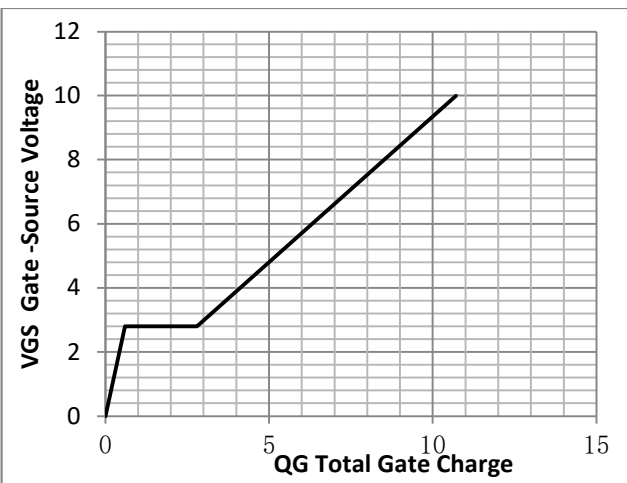

Fig.9 SOA Maximum Safe Operating Area

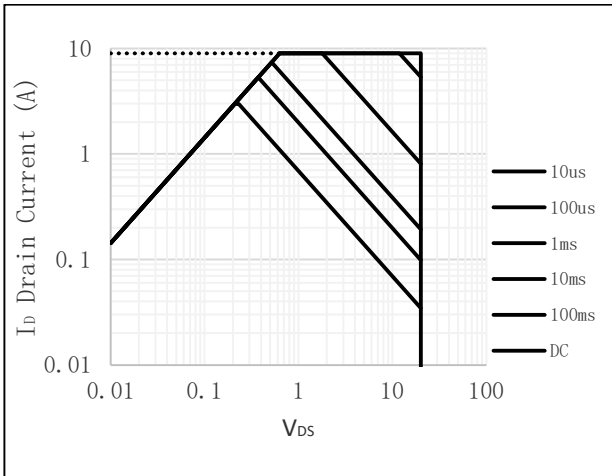
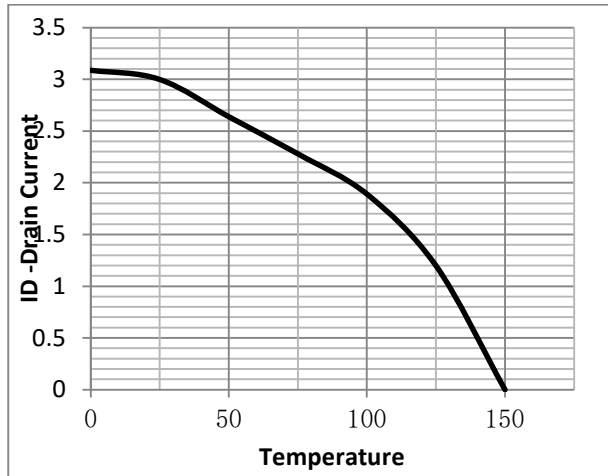

Fig.10 ID-Junction Temperature



•Test Circuit

Fig.1 Gate Charge Measurement Circuit

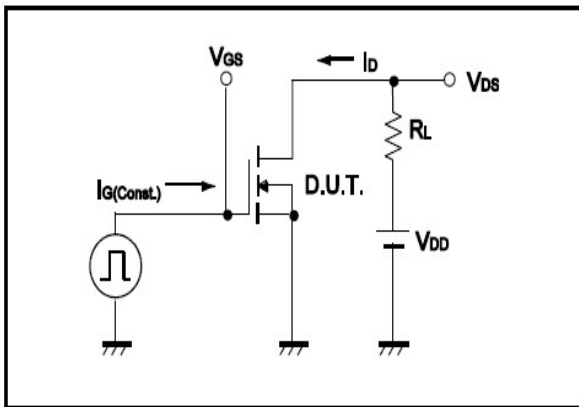

Fig.2 Gate Charge Waveform

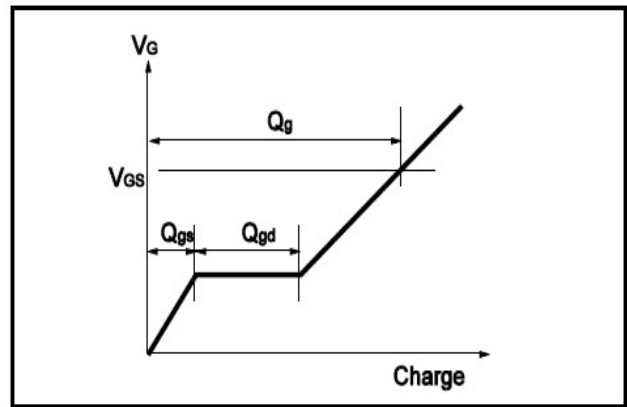

Fig.3 Switching Time Measurement Circuit

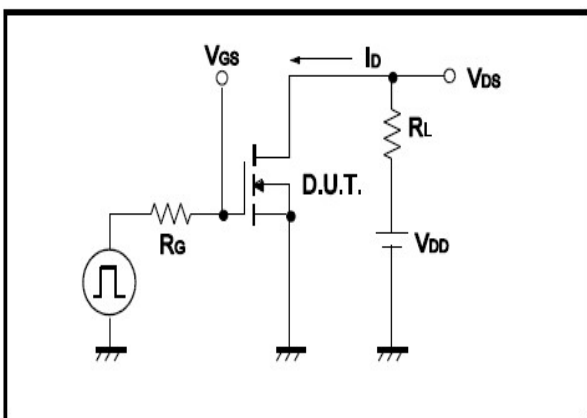

Fig.4 Switching Time Waveform

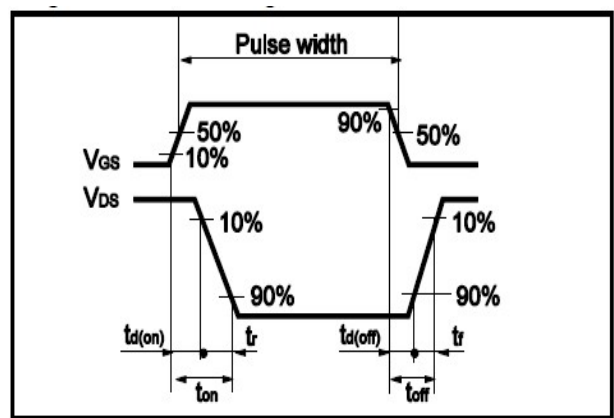

Fig.5 Avalanche Measurement Circuit

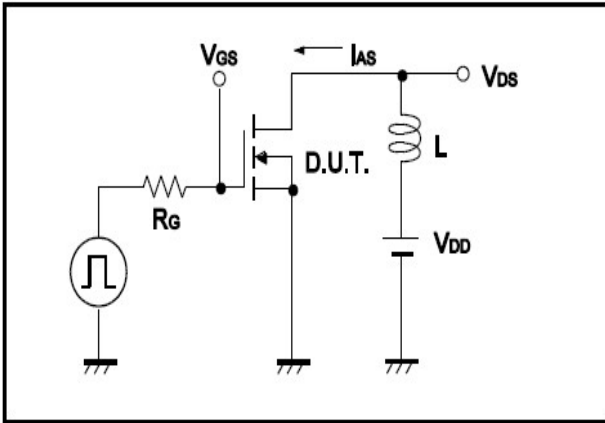
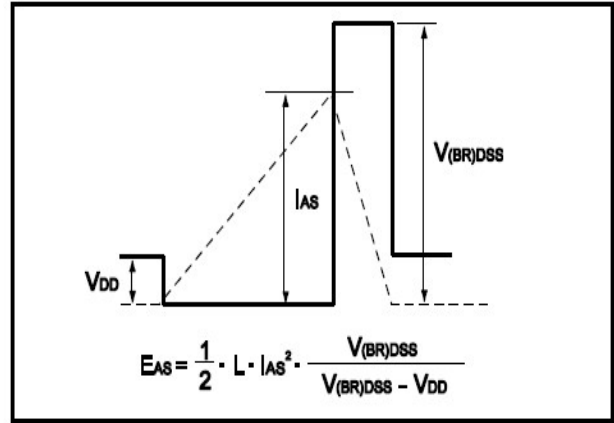

Fig.6 Avalanche Waveform





•Dimensions(DFN2*2)

